

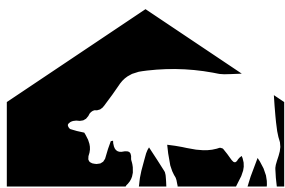

LIVESTOCK SUSPENDED FLOORING SYSTEMS



Precast livestock suspended flooring systems
Including slats, cubicles, gangs, support beams and passage covers



DAVID R BEECH
BARN EQUIPMENT

CALL US **01477 544 551**
EMAIL: **ENQUIRIES@DAVIDRBECH.COM**

END CUBICLE WALL

Easily fitted into position in minutes saving on the time and effort required for building and plastering a block wall.

- Compliments our entire range of cubicle bases
- Extremely robust product
- Chamfered corners eliminating risks to animal welfare

IN HOUSE WATER TROUGH

The curved narrow trough eliminates problems associated with a shortage of drinking points while optimising space in-house.

- Rounded corners ensure animal safety and maximise number of animals that can drink at one time
- Trough is fitted with a 75mm bung and drains in less than 2 minutes.



FOOTBATH

Designed for use on a solid floor or suspended above tank, the footbath features a quick emptying mechanism.

- Includes a slightly roughened floor as standard, to provide secure footing for livestock
- Loss of expensive solution prevented through curved inner wall design
- Variable dimensions available
- Footbath supplied with a 100mm (4") bung to facilitate emptying



BENEFITS OF SLATTED FLOORING

Slats allow the slurry to drop quickly into the tank below

- Cows feet are drier, therefore reducing the risk of digital dermatitis & slurry heel

Efficient storage of slurry

- Saves valuable farmyard space with storage
- Rainwater does not take up valuable capacity

Reduces dependency on straw bedding

- More cost effective with escalating cost of straw
- Straw can soften cows feet - higher Foot Trimmer/Vet bills
- Cleanliness – poorly managed straw bedding can lead to higher cell counts

Efficiency Savings

- Allows for more efficient stock management systems
- Scraping requirement greatly reduced by comparison solid passages

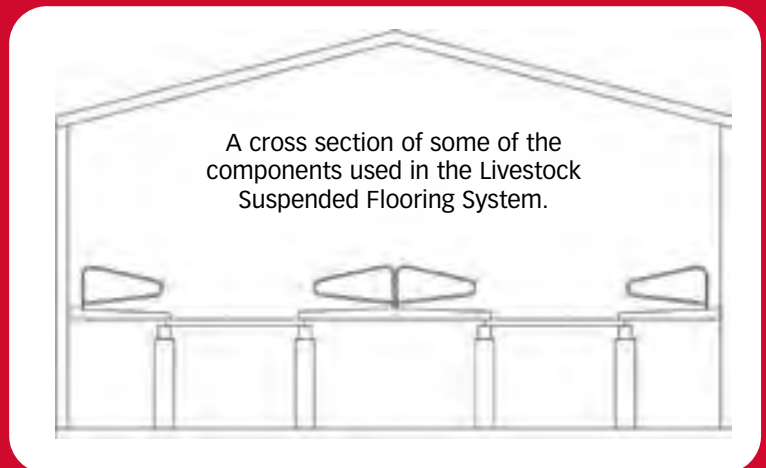

AVAILABLE WITH **SUREFOOT**™ FINISH: (See our SUREFOOT brochure for more details)

50% MORE GRIP THAN CONVENTIONAL SLATS



LIVESTOCK SUSPENDED FLOORING

CATTLE SLATS

Suitable for dairy and beef cattle, the Moore Concrete range of cattle slats are manufactured to the highest possible standards.

180mm (7") Gang Slat

- Slats are designed to provide optimum space to surface ratio
- A steep release angle allows slurry to drop immediately to the tank, keeping cattle clean
- A fully tested comparable range of slip-resistant slats is also available
- Individual specification will be considered

250mm (10") Gang Slat

- The six bar profile allows the strength required for modern day farm machinery
- Slat sides are of the smoothest finish for cleanliness

We are also specialists in manufacturing slip resistant slats.

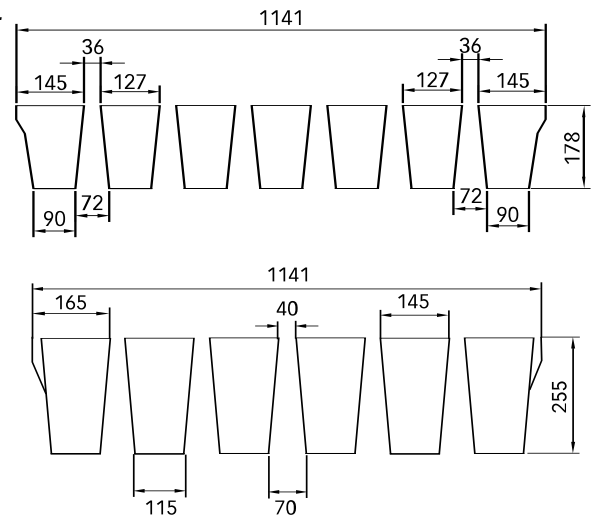

AVAILABLE WITH **SUREFOOT**™ FINISH:

50% MORE GRIP THAN CONVENTIONAL SLATS

SAFETY SLATS / AGITATION POINTS

Used in conjunction with any of the above slat range, the safety gang provides trouble free access to the slurry tank, and is suitable for all types of slurry mixing and pumping systems.

- Each slat features a slatted concrete and a lockable galvanised safety grid below
- Solid manhole slabs are available in 1500mm or 1800mm widths and can include a 900sq lid

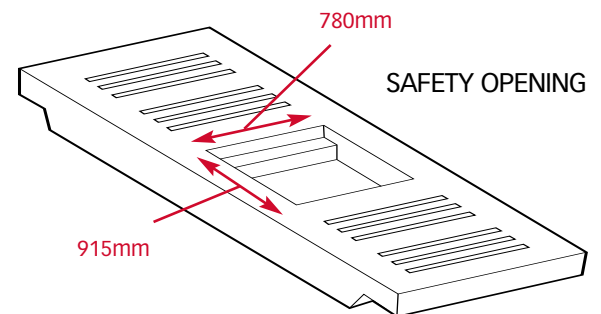

MULTI-PURPOSE SLATS

Suitable for sheep, cows, calves and pigs, Moore Concrete manufacture a range of multi-purpose slats up to 3960mm long.

- The varying slat depth allows for free flow of slurry into collection tank
- A fully tested comparable range of slip-resistant slats is also available

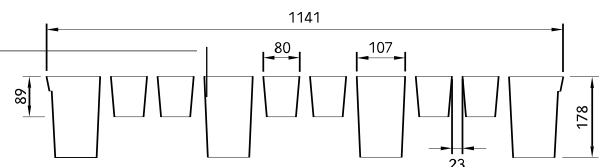

STRAW BEDDING SLATS

Suitable for use in calving pens and areas where young or smaller stock are housed.

- Comprised of an eight bar gang with 15mm spacing preventing loss of straw through spacing in slats
- Designed to support the weight of modern farm equipment

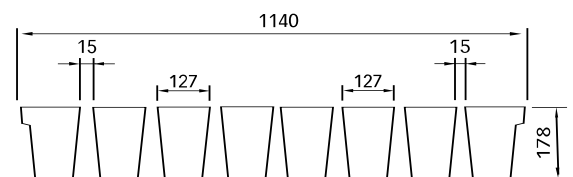



CATTLE SLATS	Max Length	Depth	Axle Loading
180mm (7") Standard	3960mm (13')	180mm (7")	4.5ton
180mm (7") Heavy Duty	3960mm (13')	180mm (7")	6.0ton
255mm (10") Standard	5000mm (16'5")	255mm (10")	6.0ton
255mm (10") Heavy Duty	5000mm (16'5")	255mm (10")	10.0ton
SAFETY SLATS	Max Length	Depth	Axle Loading
180mm (7") Safety	3960mm (13')	180mm (7")	**
255mm (10") Safety	5000mm (16'5")	255mm (10")	**
DUAL PURPOSE SLATS	3960mm (13')	180mm (7")	2.5ton
STRAW BEDDING SLATS	3960mm (13')	180mm (7")	8.0ton
PASSAGE COVER	6096mm (20')	150mm (6")	*
SUPPORT BEAMS	4570mm (15')	305mm (12")	**
HEAVY DUTY SUPPORT BEAMS	4570mm (15')	305mm (12")	10.0ton

* Applying a structural screed and a layer of A393 mesh increases axle loading up to 10 ton – for details speak to a member of our sales team.
 ** Refer to sales team.

CUBICLE BASES

Precast single and double cubicle bases offer many advantages over traditional in situ construction.

- **Speed of installation** as base arrives on site ready for the cubicle and mattress. There is also no need to prepare level stones or a sloping concrete bed
- **Space Optimisation** Extra slurry storage available under the cubicle beds. All units can be suspended over the tank, with no need for floor slabs
- **Finish** Brushed finish to allow grip
- **Hygiene** Units can be positioned on the slats to allow the free flow of slurry away from the heel-stone. The units are also compatible with scraper systems
- Differing heights and finishes of base are available

CUBICLE BASES	Min (L)	Max (L)	Min Head Height (H)	Min Heel Height (H)
Single Wet Cast	2135mm	2745mm	280mm	190mm
Single Dry Cast	2135mm	2745mm	225mm	150mm
Double	3960mm	5485mm	255mm	180mm

* All cubicle bases are manufactured at 1141mm wide.

Single Sloping Cubicle Base

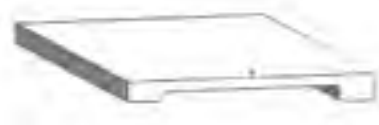

Double Sloping Cubicle Base



PASSAGE COVERS

The use of a prestressed suspended passage cover allows for rapid installation on site while maximising slurry storage capacity.

- Each unit features a tongue and groove interlocking system to facilitate rapid positioning on site
- Available in widths of either 1200mm or 600mm
- Can be manufactured to include manhole on request

SUPPORT BEAMS

High quality prestressed support beams up to an axle loading of 10 ton available.